

**MIDI PROGRAMMABLE  
TUBE PREAMP  
OWNER'S MANUAL MP-1**

**ADA SIGNAL PROCESSORS, INC.**  
7303D Edgewater Drive, Oakland, CA 94621-3095  
Phone: (415)632-1323, Telex: 470880, FAX: 01 4156329358



MIDI VALUE	MASTER GAIN DISPLAY VALUE
0	0
1	.1
2	.2
3	.3
4	.4
5	.5
6	.6
7	.7
8	.8
9	.9
10	1.0
11	1.5
12	2.0
13	2.5
14	3.0
15	3.5
16	4.0
17	4.5
18	5.0
19	5.5
20	6.0
21	6.5
22	7.0
23	7.5
24	8.0
25	8.5
26	9.0
27	9.5
28	10.0

MIDI VALUE	BASS & TREBLE DISPLAY VALUE	MID & PRESENCE DISPLAY VALUE
0	-16	-12
1	-12	-10
2	-9	-8
3	-6	-6
4	-4	-4
5	-2	-2
6	0dB	0dB
7	2	2
8	4	4
9	6	6
10	9	8
11	12	10
12	16	12

## CONTENTS

1.0	INTRODUCTION
1.1	QUICK SET-UP GUIDE
1.2	FEATURES
1.3	PRECAUTIONS
2.0	CONTROL FUNCTIONS
2.1	REAR PANEL
2.2	BATTERY
3.0	INITIAL SET-UP
3.1	ACCESSING PROGRAMS -CHANGE MEMORY NUMBER WITHIN THE SAME BANK -CHANGE TO NEW BANK AND MEMORY NUMBER
3.2	EDITING AND STORING PROGRAMS -EXAMINE PROGRAM PARAMETERS -EDIT AND STORE A PROGRAM
3.3	CREATING TONE
3.4	USING THE CLIP LED'S
3.5	USING THE EFFECTS LOOP
3.6	LOAD PRESET PROGRAMS
4.0	MIDI FUNCTIONS -SELECT MIDI CHANNEL -SELECT PROGRAM & MEMORY NUMBER
4.1	ONE-TO-ONE MAPPING
4.2	REMOTE
5.0	SELF-DIAGNOSTICS
6.0	MEMORY PRESET SETTINGS
7.0	SPECIFICATIONS
7.1	MIDI SPECIFICATIONS
7.2	SOFTWARE UPDATES
8.0	RETURNING UNITS FOR SERVICE
9.0	WARRANTY
9.1	OPTIONAL EXTENDED WARRANTY
9.2	TUBE REPLACEMENT
10.0	SYSTEM EXCLUSIVE MESSAGES
10.1	SYSTEM EXCLUSIVE MAP
10.2	SYSTEM EXCLUSIVE PARAMETER VALUES

## 10.1 SYSTEM EXCLUSIVE MAP

HEX ADDRESS	1 BYTE EACH
00	Overdrive 2
01	Overdrive 1
02	Master gain
03	Bass
04	Midrange
05	Treble
06	Presence
07	Effects (0=Out, non-zero=In)
08	Depth (000=Off, 100=Max value)
09	Rate (000=Off, 001=.1Hz, 100=Max)
0A	Voicing (0=S.S., 1=Dist., 2=Clean)

**Marshall** is a registered trademark of Jim Marshall Ltd.  
**Fender** is a registered trademark of Fender Musical Instruments  
**Rockman** is a registered trademark of Scholz Research & Development, Inc.

## 1.1 QUICK SET-UP GUIDE

*Note: The MP-1 is a preamp and must be connected to a power amp in order to play through loudspeakers.*

### INITIAL PREPARATION:

- 1 Connect guitar to front panel input jack.
- 2 Connect studio (line) level signals to the rear panel input jack.
- 3 Connect amplifier to one of the two rear panel outputs. For stereo, run both outputs to separate power amps.
- 4 If MP-1 outputs are connected to power amps (instead of guitar amps) or a professional mixing console, flip the top panel slide switch towards the rear panel to the Line position.
- 5 Turn the power switch ON.
- 6 Adjust volume with Output Level control.

### SELECT MEMORY NUMBER:

- 1 Use ^ v buttons to scroll through memory numbers 1 thru 128.
- 2 Or select a bank by pressing the BANK button, select bank number 0 thru 12 using ^ v buttons, followed by pressing any button labeled 0 thru 9.

### CREATE THE RIGHT TONE

- 1 Press EDIT button.
- 2 Select VOICING button.
- 3 Use ^ v buttons to select Clean Tube, Distortion Tube, or Solid State circuit.
- 4 Select Master Gain.
- 5 Use ^ v buttons to change level of drive from 1 to 10.
- 6 Repeat steps 4 and 5 for Overdrive 1 and 2. In Solid State mode, the level of Overdrive 2 controls the amount of compression.
- 7 Follow the same procedure for shaping EQ.
- 8 Select Chorus Depth button.
- 9 Use ^ v buttons to adjust depth from 0 to 100%.
- 10 Select Chorus Rate button.
- 11 Use ^ v buttons to adjust rate of sweep from .1 Hz to 10 Hz, or to turn rate off (0).
- 12 To abandon this edit session, press EDIT button. LED's turned off and changes not saved. To store changes, see below.

## SET PARAMETERS

<F0>	SYSEX
<0D>	ADA Identifier
<cc>	Channel number
<dd>	Device number
<06>	Set parameter command
<PP>	Program number
<NN>	Number of parameters
<bb>	Base parameter number
<V1>	Parameter value
•	
• .	
• . .	
<VN>	Parameter n value
<xx>	Message checksum
<F7>	EOX

## SET PARAMETERS RESPONSE

<F0>	SYSEX
<0D>	ADA Identifier
<cc>	Channel number
<dd>	Device number
<00>	Response ID
<06>	Response type
<xx>	Message checksum
<F7>	EOX

- Sets one or more parameters in a program
- Program number 7F specifies the current working parameter registers.
- A zero response indicates no errors were detected, a non-zero response indicates that a bad parameter number or value was detected.

## 1.2 FEATURES

- √ Unique Tri-State Voicing option for choice of Clean Tube, Distortion Tube, or Solid State circuit for each program.
- √ Two low-noise 12AX7A / 7025 tubes.
- √ 128 programs.
- √ Three programmable gain controls for each program.
- √ Four band programmable EQ including 16dB boost / cut for bass and treble.
- √ Fully programmable stereo chorus and doubler.
- √ Programmable effects loop with adjustable send / receive level.
- √ Stereo headphone jack with level control.
- √ Stereo outputs switchable from line level (to mixing board) to instrument level (to guitar amp).
- √ 1/4" instrument level input jack on front panel for easy access.
- √ Active balanced input on rear panel for mixing boards.
- √ Output level knob for fast volume adjustment without affecting tone.
- √ Programmable compression level in Solid State mode.
- √ Received MIDI program numbers are re-assignable (mappable) to any MP-1 memory number.
- √ MIDI In, Out and Thru.
- √ Selectable MIDI channel including ALL channels (OMNI) and NO channels (OFF).
- √ Lexan membrane switch front panel replaces pots. No contamination from dust or liquids.
- √ Optional MC-1 MIDI CONTROLLER footswitch provides instant access to any program for on-stage control.
- √ Self-diagnostics check unit during powerup.
- √ Instantaneous logic-controlled FET switching.
- √ EPROM updates will be available for future system expansion.
- √ State-of-the-art software implementation including SYSEX and MIDI Time Code for computer-controlled applications.
- √ Simple programming routine.
- √ One year parts and labor warranty. Extended 3 year warranty available.

## DIAGNOSTIC STATUS RESPONSE

<F0>	SYSEX
<0D>	ADA Identifier
<cc>	Channel number
<dd>	Device number
<00>	Response ID
<03>	Response type
<ss>	Response (may be one or more bytes)
<xx>	Message checksum
<F7>	EOX

- Retrieves the most recent diagnostic result
- The first byte of the response =0 if no error occurred, and ≠ 0 if an error occurred.
- Some tests may return multiple bytes on a device and test specific basis.

## DEVICE REASSIGN

<F0>	SYSEX
<0D>	ADA Identifier
<cc>	Channel number
<dd>	Device number
<04>	Device reassign command
<ee>	New channel number
<ff>	New device number
<xx>	Message checksum
<F7>	EOX

## DEVICE REASSIGN RESPONSE

<F0>	SYSEX
<0D>	ADA Identifier
<cc>	Old channel number
<dd>	Old device number
<00>	Response ID
<04>	Response type
<ee>	New channel number
<ff>	New device number
<xx>	Message checksum
<F7>	EOX

- Causes a device to switch channels or device numbers

## DUAL FUNCTION SWITCHES:

### IN NON-EDIT MODE

<b>BANK</b>	Enter a Bank number (0 thru 12) by using the ^ v buttons. After Bank selection, you must select the “ones” digit using the buttons labeled (0 thru 9) to exit Bank select mode
<b>0 THRU 9</b>	Selects the “ones” digit of the memory number.
<b>MIDI CHNL</b>	Selects the MIDI channel mode. Use the ^ v switches to select the MIDI channel number from 1 - 16, ALL (OMNI) or OFF.
<b>PRGM</b>	Selects the <u>external</u> MIDI program number that is assigned to the <u>internal</u> memory number on the MP-1. The normal relationship is 1-to-1 (i.e., external MIDI program #1 selects internal memory #1, 2 to 2, etc.). When the LED is lit, use the ^ v switches, the bank switch and / or a number from 0 to 9 to select the external MIDI program number.
<b>MEM</b>	Selects the <u>internal</u> memory number on the MP-1 that is assigned to the <u>external</u> MIDI program number. When the LED is lit, the display reads the internal memory number. Select the MEM number using the ^ v switches, the bank switch, and / or a number from 0 to 9. To record the change, press the switch again or press the PRGM button to continue.

## 9.0 WARRANTY

The MP-1 (excluding tubes) is warranted against defects in material and workmanship for a period of three hundred and sixty-five (365) days from date of purchase. Original factory-installed tubes are warranted against defects in material and workmanship for a period of ninety (90) days from the date of purchase. ADA will replace defective parts and make necessary repairs at no charge if factory inspection reveals faulty workmanship or material. Neither MP-1 nor tube warranties cover damage due to misuse, accident or neglect. ADA retains the exclusive right to make such determination on the basis of factory inspection. Products returned to the factory must first receive authorization from ADA and must be shipped prepaid. The "return authorization number" must be printed on the outside of the container or the shipment will not be accepted by ADA. This warranty remains valid only if repairs are performed by ADA, and provided that the serial number on the unit has not been defaced or removed. This warranty is expressly in lieu of all other warranties either expressed or implied.

## 9.1 OPTIONAL EXTENDED WARRANTY

An optional three year warranty is available on the MP-1 if the extended warranty protection policy is purchased within the first 90 days of purchase. The policy covenants and restrictions are the same as our standard one year warranty, only the term is increased an additional three years after the original factory warranty expires. Enclosed is an application for the extended warranty protection policy.

## 9.2 TUBE REPLACEMENT

Your factory installed 12AX7 tubes should last approximately two years. Since these are not power tubes, the lifespan is probably longer than you expect. When tube replacement becomes necessary, we recommend that you use only ADA factory - tested replacement tubes for the cleanest and quietest performance possible. These can be obtained from ADA or an authorized ADA dealer. For more information, call ADA Customer Service.

## 2.1 REAR PANEL

<b>FUSE</b>	Externally accessible 0.5 AMP fuse. Replace with equivalent type and rating only.
<b>POWER SWITCH</b>	ON / OFF rocker switch (located near power supply to prevent leakage of AC line hum into the audio circuitry).
<b>PHANTOM POWER</b>	A 9V AC / DC coaxial power input jack used to supply phantom power to the optional MC-1 MIDI Controller or any other Phantom MIDI Device. <b>Use with a 7 - pin MIDI cable in the MIDI IN jack, and do not connect an AC adaptor to the MC-1's rear panel power jack.</b>
<b>MIDI THRU</b>	Passes all MIDI data received at the MIDI IN connector to subsequent MIDI instruments.
<b>MIDI OUT</b>	Transmits MIDI information originated by the MP-1 to subsequent MIDI instruments.
<b>MIDI IN</b>	Receives MIDI. Permits MP-1 programs to be automatically selected via a MIDI signal. The MP-1 recognizes program change, SYSEX and MIDI Time Code (MTC).
<b>HEADPHONE: JACK</b>	1/4" stereo phone jack. Drives headphones of 600Ω or more.
<b>LEVEL</b>	Provides full mute to +17dB above internal signal level.
<b>EFFECTS LOOP: LEVEL</b>	Provides 20dB boost or cut to the send / receive signal. Dual-gang pot insures unity gain at all settings.
<b>RECEIVE</b>	Single-ended 1/4" phone jack. Maximum signal level is +30dBV.
<b>SEND</b>	Single-ended 1/4" phone jack. Variable from instrument to line level.

**DIMENSIONS** L 10.5" x W 19" x H 1.75" (483x44x269 MM).

**WEIGHT** 6 lbs. (2.72 kg);  
8 lbs (3.63kg)shipping.

**OPTIONS** 220VAC, 50 / 60 Hz,  
Extended 3 year warranty,  
Software updates,  
ADA replacement tubes.

**ACCESSORY** MC-1 MIDI Foot Controller.

- All specifications subject to change without notice.

## 7.1 MIDI SPECIFICATIONS

**SPECIFICATION** 1.0, Rev 3.3

**MIDI TIME CODE** Recognized in Level 3 Software.

**CHANNEL** 1-16, OMNI, OFF

**PROGRAM CHANGE** External Programs: 1 - 128.  
Internal Memory: 1 - 128, OUT. (bypass condition).

**PARAMETER CHANGE  
& DUMP** SYSTEM Exclusive

## 7.2 SOFTWARE UPDATES

By sending in your warranty card, you are entitled to one free EPROM software update. Thereafter, updates are \$50 each. You can send your unit to ADA for installation or we can send you the EPROM. Always refer to qualified service personnel for installation.

When you power-up the MP-1, the software revision level is indicated on the LED Readout before the word "ADA" flashes.

Level 1 software offers the following features: 100% compatability with MIDI Spec 1.0. In addition, ADA has pioneered a phantom power system which sends AC power thru a 7-pin MIDI cable to controllers such as ADA's MC-1 MIDI CONTROLLER.

Level 2 software offers upload and download of MP-1 parameters to computers with a MIDI interface using System Exclusive Messages. In addition, MP-1 parameters may be accessed in real-time using SYSEX messages.

Level 3 software will read MIDI Timecode for synchronizing with SMPTE Time Code devices, and will be able store a Q-LIST of MTC program and parameter changes.

These are the updates that we now know about. As MIDI evolves, so will the MP-1. its capabilities will continue to expand!

## 3.0 INITIAL SET-UP

- 1 Set MP-1 rear panel POWER SWITCH to OFF.
- 2 Connect your guitar to the front panel INPUT jack. If you are connected to a professional mixing console, run your signal source to the LINE INPUT on the rear panel. If both inputs are connected, only the front panel input will be operative.
- 3 Connect MP-1 OUTPUTS to your amplifier or mixer inputs.
- 4 If MP-1 outputs are connected to a power amp or other line input, flip the top panel slide switch towards the rear panel to the LINE position. **WARNING: Do not use LINE position when MP-1 is connectd to guitar amplifier inputs.**
- 5 If using MIDI:
  - A. Connect the MIDI Out of your MIDI footswitch or other MIDI controller to the MIDI IN jack on the MP-1.
  - B. When using a MIDI device before the MP-1 and a MIDI device following the MP-1, use the MIDI Thru jack to send the external program number. Use the MIDI Out jack to send the MP-1's internal memory number.
  - C. When using the MP-1 as the first in a series of MIDI devices, use the MIDI Out jack to send the MP-1's internal memory number.
- 6 If you own the optional MC-1 MIDI footswitch, connect the MIDI In Jack on the MP-1 to the MC-1 with the MIDI CABLE. You can use a standard 5-pin MIDI cable and plug the AC ADAPTOR into the MC-1 or you can use the ADA 7-pin phantom MIDI cable and power the MC-1 thru the 7-pin cable (eliminating the need to have power near the footcontroller); when using the 7-pin cable, the AC ADAPTOR plugs into the 9V AC / DC jack on the MP-1 rear panel.
- 7 If you are using effects with the MP-1, connect the EFFECTS LOOP SEND jack to the input jack of the first effect in use.
- 8 Connect the EFFECTS LOOP RECEIVE jack to the output of the last effect in your loop.
- 9 See Section 3.4 for full description of correct effects loop level settings.

## 6.0 MEMORY PRESET SETTINGS

The following 29 memory presets are loaded into the factory preset Program Storage Registers

MEM NO.	PROGRAM	OD1	OD2	MASTER	PARAMETER							
					BASS	MID	TREBLE	PRSNC	LOOP	DEPTH	RATE	VOICING
1	MARSHALL™	5.0	5.0	6.0	6	4	4	12	OUT	0	0	DIST
2	NOTCHED GRIND	4.8	3.2	8.0	4	8	6	12	OUT	21	0	CLEAN
3	LIQUID GRIND	6.0	6.0	7.0	2	2	4	6	OUT	14	1.2	DIST
4	EDGE RHYTHM	4.6	4.4	7.5	0	0	4	4	OUT	1	1	CLEAN
5	SATURATED NOTCH	10.0	10.0	6.0	2	8	9	6	OUT	100	0	CLEAN
6	CLEAN WITH COMPRESSION	4.0	4.0	9.5	2	0	4	4	OUT	1	1	S.S.
7	CLEAN & WARM	3.0	3.0	9.5	6	4	2	12	OUT	100	1	CLEAN
8	COMPRESSED VIBRATO	4.0	9.0	7.5	0	12	6	10	OUT	34	9.0	S.S.
9	OVER CHORUSED CLEAN	2.6	6.5	10.0	4	10	12	4	OUT	30	1.8	S.S.
10	BEEFY FENDER™	3.0	9.0	6.5	0	4	9	2	OUT	0	0	CLEAN
11	BRITTLE RHYTHM	3.0	3.0	7.5	4	4	9	8	OUT	30	.3	DIST
12	CHORUSED LEAD	9.0	5.5	5.5	4	4	2	10	OUT	23	1	DIST
13	CLASSIC CLEAN	3.6	5.0	7.5	2	4	16	12	OUT	0	0	S.S.
14	SHIMMERING CLEAN	2.8	2.4	10.0	0	10	16	12	OUT	54	1.2	CLEAN
15	SLAP FUNK	10.0	10.0	8.5	2	8	4	8	OUT	28	0	S.S.
16	FLANGED ROCKMAN™	4.4	4.4	6.0	2	8	4	10	OUT	100	.3	DIST
17	TUBULAR METAL	10.0	3.6	7.5	2	12	2	2	OUT	14	0	DIST
18	CLEAN FLANGE	5.0	1.4	9.5	6	0	4	12	OUT	100	1	S.S.
19	STRAIGHT AHEAD METAL	3.8	7.0	7.0	2	6	0	4	OUT	0	0	DIST
20	CLASSIC OVERDRIVE	5.0	5.5	7.5	6	12	4	6	OUT	47	0	CLEAN
21	DAMPED LEAD	9.5	9.0	7.0	9	6	6	8	OUT	100	0	CLEAN
22	NOTCHED LEAD	10.0	4.8	5.5	6	4	6	12	OUT	100	0	DIST
23	DRY LEAD	7.0	5.5	5.5	4	4	9	8	OUT	0	0	DIST
24	ROCKMAN™	9.5	3.0	5.5	0	6	12	4	OUT	68	0	DIST
25	CRYSTAL CLEAN	4.0	8.5	8.0	9	6	6	8	OUT	100	0	S.S.
26	SPARKLING CHORUS	2.6	2.6	10.0	9	4	9	12	OUT	26	.3	CLEAN
27	COMPRESSED CHORUS	4.2	10.0	6.5	9	4	16	12	OUT	100	.2	S.S.
28	MILD GRIND	4.2	4.2	7.0	9	8	2	12	OUT	100	1	CLEAN
29	COMPRESSED RHYTHM	5.0	8.0	8.5	4	8	6	12	OUT	60	0	S.S.

## 3.2 EDITING AND STORING PROGRAMS

The EDIT function is used to look at specific parameter values and to create or modify a program

The STORE function is used to take the program you are listening to in the Working Register and store it in a specific internal memory number location. There are 128 locations. **To save your own programs, you must use the STORE function. If you do not STORE an edited program, it will be erased when you select a different program.**

When EDIT is pressed, the display reads "Edit". From the beginning of an edit session until the newly edited program has been stored or abandoned, the MIDI interface is disabled. This prevents a MIDI selected program from overwriting an edit session. Pressing the EDIT button will exit the edit session. If you want to save your edit session, press the STORE button to put the unit into the Store mode. If a change is made to a parameter while in the Edit mode, the EDIT LED will blink until the Edit mode is exited to remind you that if you don't store the program you will lose it if you select a different program to listen to. The memory number will blink until the new data has been stored or abandoned.

Once in Edit mode, pressing a parameter button selects an alternate function for editing, illuminates the associated LED and puts the current value on the display. Pressing the ^ v buttons will increment or decrement the displayed value. If the button is held down, the display value will increment or decrement until the maximum or minimum value is reached.

### EXAMINE PROGRAM PARAMETERS

- 1 Press BANK, press ^ v buttons until 0 is displayed on the tens digit of the display, then press 1. You are now in program 1.
- 2 Press EDIT button.
- 3 Choose the OVERDRIVE 1. The value "5.0" is displayed on the LED READOUT. Next, choose OVERDRIVE 2, its value is "5.0". Continue this process by examining MASTER GAIN, BASS, etc. An LED on each button "blinks" when the parameter has been selected for modification.
- 4 Press the EDIT button when you are through examining the parameter values. The EDIT LED will turn off, and you will be returned to Program 1.



## SELECT PROGRAM & MEMORY NUMBER

- 1 Connect the MIDI Out of a MIDI device to the MIDI IN jack on the MP-1. Test if reception is occurring by changing programs on the sending device. As you change programs on the external device, the MP-1's LED display will change.
- 2 Press PRGM. The LED flashes.
- 3 Select a new PRGM number by (a) scrolling through the program numbers with the  $\wedge \vee$  buttons, or (b) go directly to a program using the BANK,  $\wedge \vee$  and 0-9 buttons.
- 4 Press MEM. LED flashes.
- 5 Select a new MEM number by (a) scrolling through the program numbers with the  $\wedge \vee$  buttons or (b) go directly to a program using the BANK,  $\wedge \vee$  and 0-9 buttons.
- 6 Press MEM to store and exit.

### 4.1 ONE-TO-ONE MAPPING

The MP-1 is shipped with a 1-to-1 program / memory map, i.e., external MIDI program 1 is mapped to internal memory 1, external 2 to memory 2, etc. If you want to restore the 1-to-1 relationship:

- 1 Press STORE. STORE LED will blink.
- 2 Press BANK, hold down and simultaneously press 2.  
Display reads "Load".

### 4.2 REMOTE

The ADA MC-1 is a universal MIDI CONTROLLER that permits sending program change commands to the MP-1 and the rest of your MIDI equipment.

Two options exist for using the MC-1 with ADA equipment. First you can use an ADA 7-pin MIDI CABLE to phantom power the MC-1. This prevents the need to run AC power to the footswitch (the AC ADAPTOR is connected to a jack on the rear of the MP-1 labeled 9V AC/DC). Second, you can use a standard 5-pin MIDI cable and plug the AC ADAPTOR directly into the MC-1.

In the SOLID STATE mode, OVERDRIVE 2 functions as your compression control. The higher the value, the more compression you have, to a maximum of approximately 40dB. Use the compression to soften your attack and achieve better sustain.

The MASTER GAIN sets your pre EQ level. When the MASTER GAIN button is selected, the  $\wedge \vee$  buttons will change the value from 0 to 10. As you create programs (the EDIT LED on), any change of the VOICING mode will reset the MASTER GAIN level to 0. This is necessary to suppress any loud surprises.

The stereo analog CHORUS is a perfect complement to the warmth of the MP-1's tube circuitry, but it will do more than produce great chorusing. If you set the CHORUS RATE to 0 (off), the CHORUS DEPTH functions as a very short delay, producing a wide range of notch filter and doubling effects. You can achieve a hollow, out-of-phase "Strat"-type sound, and fine-tune it by taking the CHORUS DEPTH value up or down.

### 3.4 USING THE CLIP LED'S

Your MP-1 is digitally controlled. The MP-1 circuit is monitored in four points for clipping of the digital controls to help you prevent unwanted kinds of distortion from coloring your tone. Always pay attention to your CLIP LED'S. If a CLIP light remains on while you play, you should lower the value of the control that is indicated. If you like the tone that you have, you can still keep that tone, but eliminate the unwanted clipping.

For example, if the EQ is clipping, but you want the same curve, you can either lower the MASTER GAIN (signal going into the EQ), or lower all of the EQ values the same amount.

### 3.5 USING THE EFFECTS LOOP

The EFFECTS LOOP LEVEL control on the rear panel will allow you to achieve the quietest possible performance, no matter what kind of effects you are using. The level control is configured to insure that you have the same overall signal level whether the effects loop is in or out, provided the effects in the loop are set for unity gain.

Follow this general procedure:

- 1 If you are using an effect with only one level control, set your effects device to unity gain. You can test for unity gain by connecting the EFFECTS SEND to your effect input, and running the effect output directly to your amp. Adjust the level on your effects device so that you have the same volume when the effect is switched in or out.
- 2 Set the EFFECTS LOOP LEVEL at the highest possible setting without clipping the effect's input.
- 3 If you are using a line level effect with two level controls, set your EFFECTS LOOP LEVEL control to 1 o'clock (0 dB gain). Adjust the input level on your effect to the highest possible setting without clipping, and set the output level control on your effect to achieve unity gain in your effect. You can test for unity gain as described in step 1.
- 4 Check for distortion and excess noise. If your effect is clipping, turn your EFFECTS LOOP LEVEL control counterclockwise.

### 3.6 LOAD PRESET PROGRAMS

There are 29 factory preset programs (1-29) that can be loaded into the internal program memory via the front panel. These can be loaded at one time, or they can be brought into the MP-1's working register one at a time (Level 2 software). To load all 29 programs, press the STORE button. The STORE button will blink. Press BANK and, while holding it down, press 1. Display reads "LP" (Load Programs). Programs 1 thru 29 will be erased and overwritten by the preset programs. Reference section 6.0 MEMORY PRESET SETTINGS for a description of factory presets. To load just one program (Level 2 software), press BANK and while holding it down, press CHORUS RATE. "P" will be displayed, indicating that a preset is being recalled. Now select the preset you want by using  $\Delta$ . You may use or edit this program without erasing any of your own programs, or you may save it by using the STORE sequence.

### 4.0 MIDI FUNCTIONS

The MP-1 has MIDI In, Out and Thru and recognizes program change, SYSTEM Exclusive and MIDI Time Code.

To send and receive MIDI data, you must select a MIDI channel. You have the option of selecting an individual MIDI channel, (1-16), or you can send or receive on all 16 MIDI channels (OMNI) or you can turn MIDI off.

The MP-1 has 128 storage registers for programs. These are referred to as "internal memory". The MP-1 allows you to "map" MIDI program numbers received via MIDI IN to any "internal memory" numbers you choose. For example, if you have a MIDI foot controller connected to the MP-1, sending program change 11, the MP-1 could "map" the reception of program 11 to memory 22 or any memory location from 1 thru 128 in the MP-1. This gives you the potential of "mapping" more than one MIDI program command to the same MP-1 memory number. Other MIDI devices without this feature limit you to a one-to-one relationship, e.g., when you change to program 11 on your foot controller, the receiving device can change only to program 11.

When the PRGM or MEM buttons are in use and their corresponding LED is flashing, the MIDI interface is temporarily disabled. If the MP-1 is left with the PRGM button active, the MP-1 will display program numbers when they are received instead of internal memory numbers.

The external MIDI PRGM number range is from 1-128. The internal MEM number range is from 1-128.

#### SELECT MIDI CHANNEL

- 1 Press MIDI CHNL. To select a number from 1 thru 16, ALL (OMNI), or MIDI OFF, use the  $\Delta$  buttons to make your selection. When the display reads "ALL", the MP-1 will talk and listen to all 16 MIDI channels simultaneously. When the display reads "OFF", the MP-1 will not talk or listen to any MIDI channel. *Be sure to set the MIDI device connected to the MP-1 to the same MIDI channel as the MP-1.* (If you do not know the MIDI channel being sent by the device preceding the MP-1, set to ALL).
- 2 After selection has been made, press MIDI CHNL to save and exit.

## EDIT AND STORE A PROGRAM

- 1 Press the EDIT button.
- 2 Choose a parameter such as MASTER GAIN and decrease or increase its value with the  $\wedge$ / $\vee$  buttons.
- 3 Proceed to the next parameter following the same procedure as 2 . above.
- 4 After all changes are complete, press the red STORE button.
- 5 Increment or decrement to a bank number, and select a memory number from 0 - 9 that you want to assign to the program. The program is now stored in the selected location.

## 3.3 CREATING TONE

When the EDIT button is toggled on, you have access to the MP-1's gain and tone controls ( gray area ). The MP-1 has a unique VOICING control which allows you to create programs using ultra-high-gain DISTORTION TUBE ( display reads *TUBE* with *DIST* LED lit on the far left of the display ), CLEAN TUBE ( *CLEAN* LED lit ), or SOLID STATE ( display reads *S.S.* ). When the VOICING button is selected, use the  $\wedge$ / $\vee$  buttons to access these three choices.

The DISTORTION TUBE voice filters the pre-tube input signal for super-saturated distortion. The processor control biases the tubes for extra high gain tone. When the CLEAN TUBE is selected, the processor re-biases the tubes for clean tones. It also re-filters the input signal to give you full-range frequency response for warm Fender™- type sounds. The SOLID STATE voice bypasses the tube circuitry. This will give you a complete range of solid state sound, including chorus, adjustable compression, and notch filtering.

When setting your OVERDRIVE levels, remember that low levels followed by high levels produce more noise than the reverse. High levels of OVERDRIVE 1 will produce a distortion that has high frequency harmonic saturation, whereas high levels of OVERDRIVE 2 will produce fuller harmonic saturation. When OVERDRIVE 1 or OVERDRIVE 2 is selected, use the  $\wedge$ / $\vee$  buttons to change the levels from 0 to 10.

## 5.0 SELF DIAGNOSTICS

The MP-1's self-diagnostic program checks the unit for errors during power-up. This interactive feature pinpoints the source of problems to simplify correcting the problem.

The following chart shows the error code that will be displayed in the event of a problem, the cause of the problem, and the appropriate action for you to take.

### ERROR CODES

DISPLAY	CAUSE	ACTION
Err 1	MIDI map checksum error. All MIDI program numbers are set 1:1 with internal memory numbers.	Re-enter MIDI map assignments.
Err 2	Working register checksum error. All values of stored parameters in the working register are set to default values. All are set to 0 except effects loop is set to "out" and the clean channel is selected.	Call up another program number or re-enter parameter values via Edit session.
Err 3	MIDI control parameters checksum error. All parameters set to default values: MIDI = OFF, MIDI internal # = 1, most recently received MIDI program = 1, current program = 1 and display flashes.	Re-enter MIDI parameters via front panel.
Err 4	MIDI Time code cue-list checksum error. Cue-list is erased and flag is set to respond with error message when MTC status request is sent to the MP-1.	Re-load cue-list.
[None]	Indicates the program itself has an error. Program will not display anything and unit will not operate.	Check fuse. If good, unit requires service

- 10 Set your effect(s) power switch to the "on" position.
- 11 Set MP-1 rear panel POWER SWITCH to "on".
- 12 Set your amplifier's power switch to the "on" position.
- 13 The MP-1 will now step through its SELF\_DIAGNOSTIC program, checking a variety of functions for proper operation. If no problem exists, the DIAGNOSTIC operation is completed within eight seconds. Your MP-1 is now ready for operation. ( If a problem does occur, reference Section 5.0 SELF CHECK DIAGNOSTIC for explanation of error codes).
- 14 Observe the CLIP LED's. Remember, in order to maintain maximum performance with the least amount of noise and distortion, proper level setting is necessary. If a CLIP LED remains on as you play, an adjustment of the program setting is necessary. See Section 3.4 for a complete description.

### 3.1 ACCESSING PROGRAMS

The MP-1 is shipped from the factory with 29 preset programs. Please note that the amount of overdrive in any program will depend on the type of pickups you are using. For example, single coil pickups will require higher levels of OVERDRIVE 1 than hotter dual-coil pickups to achieve the same amount of distortion. See Section 3.3.

As you store your own programs into memory locations, you erase the formerly stored program values in the respective registers. However, you can always recall the original factory preset programs, so feel free to experiment.

#### CHANGE MEMORY NUMBER WITHIN THE SAME BANK

- 1 EDIT and STORE LED's off.
- 2 Press the desired program number button ( 0-9 ). *Only a single keystroke is required when changing the "ones" digit in a program.*
- 3 ALTERNATE TO 2. .... You can also use the ^v buttons to scroll through the numbers.

#### CHANGE TO NEW BANK AND MEMORY NUMBER

- 1 Press BANK button.
- 2 Select bank number 0 through 12 using ^v buttons.
- 3 Select "ones" digit by pressing any button labeled 0 through 9.
- 4 ALTERNATE TO 2. & 3. ...hold down the ^ or the v button with the BANK function off. The number scrolls and wraps around from 1 to 128 in either direction.

## 7.0 SPECIFICATIONS

<b>EQ</b>	Bass and Treble boost / cut 16dB; Mid and Presence boost / cut 12dB.
<b>TUBE COMPLEMENT</b>	Four stages of gain using two low noise 12AX7 / 7025 tubes.
<b>MIDI</b>	Specification: 1.0 Rev 3.3; Channel: 1 - 16, OMNI, OFF; Program Change: external programs 1-128, internal memory 1-128 and OUT ( bypass ); MIDI Time Code (MTC): recognized in Level 3 Software; Parameter Change & Dump: SYSTEM Exclusive.
<b>CHORUS DEPTH</b>	0 ( none ) to 7:1.
<b>CHORUS RATE</b>	0.1 sec. to 10 sec. and off (0).
<b>INPUT, FRONT PANEL</b>	One, 1/4" phone jack, high impedance ( 1 meg ohm ) wide range input.
<b>INPUT, REAR PANEL</b>	One, 1/4" phone jack, active balanced (30k ohm). Ring, tip, sleeve.
<b>OUTPUTS</b>	Two, single-ended 1/4" phone jacks. Synthesized complementary stereo outputs. Switchable from instrument to line level.
<b>EFFECTS LOOP, SEND</b>	Single-ended 1/4" phone jack. Variable from instrument to line level. Maximum drive on send line is + 19dBm.
<b>EFFECTS LOOP, RECEIVE</b>	Single-ended 1/4" phone jack. maximum signal level is + 30dBv.
<b>EFFECTS LOOP, LEVEL</b>	Provides 20dB of inversely proportional boost or cut to the send / receive signals. Interfaces with low-level and line-level effects.
<b>HEADPHONE LEVEL</b>	Provides full mute to + 17dB above internal signal level. Max output + 12dBm.
<b>HEADPHONE ( JACK )</b>	1/4" stereo phone jack. Drives headphones of 600 ohms or more.
<b>POWER CONSUMPTION</b>	12 watts.
<b>POWER</b>	120VAC, 50 / 60Hz.

**OUTPUT (A&B)** Two single-ended 1/4" phone jacks.  
Synthesized complimentary stereo outputs.

**OUTPUT LEVEL** Switchable from instrument level ( INST ) to line level ( LINE ). Set output level with slide switch on top panel. **WARNING: Do not connect MP-1 to guitar amplifier input with the OUTPUT LEVEL in the LINE position.**

**LINE INPUT** 1/4" phone jack for line level input signals.  
Active balanced ( see below ).

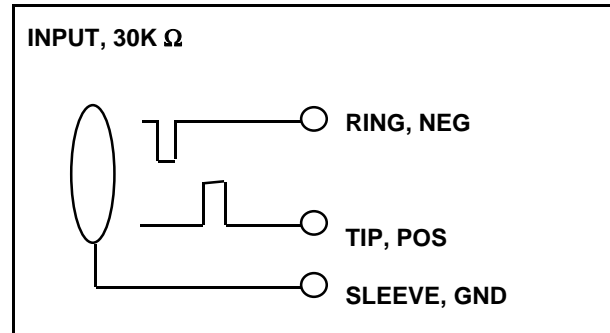

## 2.2 BATTERY

The MP-1 uses a 3-volt Lithium battery which maintains power for program storage while the MP-1 is unplugged from an AC supply. Expected battery life is 8 - 10 years. Should replacement be necessary, contact a qualified service technician.

## 8.0 RETURNING UNITS FOR SERVICE

- If your unit requires service, please do the following:
- 1 Call our Customer Service Department toll-free at:  
**(800) 241-8888**  
in CA (415) 632-1323  
for a Return Authorization ( RA ) number.
  - 2 Pack unit in its original carton with packing materials and include a note explaining the problem, your name, address, daytime phone number, and date and place of purchase.
  - 3 Write the RA number on the outside of the shipping container.
  - 4 Ship via UPS, Federal Express, or U.S. Postal Service. You pay the freight. We recommend that you insure the unit.
  - 5 If the unit is under Warranty, ADA will perform the servicing and pay the return shipping charges to you. If your Warranty Card was returned, there is a record of your purchase on file at ADA. Otherwise, send a copy of your original purchase invoice for proof of Warranty coverage.
  - 6 If the unit is not under Warranty, ADA will bill you for the servicing and return shipping charges. We require payment in advance or cash on delivery ( COD ) for these charges.

## IN EDIT MODE

<b>VOICING</b>	Allows choice for each program of Clean Tube, Distortion Tube, or Solid State circuits. Use $\wedge$ $\vee$ switches to step through choices when Voicing switch is selected.
<b>OVERDRIVE 1</b>	Attenuates pre-tube input signal. Higher gain levels of Overdrive 1 result in higher frequency harmonic saturation.
<b>OVERDRIVE 2</b>	Attenuates inter-tube signal. Higher levels of Overdrive 2 result in fuller harmonic saturation. In the Solid State mode, Overdrive 2 sets the level of compression.
<b>MASTER GAIN</b>	Post-tube, pre-EQ gain.
<b>BASS</b>	Narrow band low frequency EQ control adjustable in 2dB steps $\pm$ 16dB.
<b>MID</b>	Wide band mid frequency EQ control adjustable in 2dB steps $\pm$ 12dB.
<b>TREBLE</b>	Narrow band high frequency EQ control adjustable in 2 dB steps $\pm$ 16dB.
<b>PRESENCE</b>	Wide band high frequency EQ control adjustable in 2dB steps $\pm$ 12dB.
<b>CHORUS DEPTH</b>	Adjusts the sweep depth from 0 to 100% for a maximum range of 7:1. When the Chorus Rate is set to 0 (off), the Depth control will vary the delay time to create different filtering and doubling effects.
<b>CHORUS RATE</b>	Adjusts the speed of the sweep from .1Hz (1 cycle per 10 seconds) to 10Hz (10 cycles per second), or off (0).
<b>EDIT</b>	Place the MP-1 into the Edit mode. The display reads "Edit" until a parameter is selected. Display then shows the value of the selected parameter. Use the $\wedge$ $\vee$ buttons to increase / decrease the value of the selected parameter.
<b>STORE</b>	Place the MP-1 into the Store mode. Stores any current or edited program into any internal memory location. Press the STORE button followed by a memory location. LED indicates Store mode is engaged. LED turns off after storage is complete. If you decide not to store the current program, but you've already pressed the STORE button, you can exit the Store mode by pressing STORE again.

## 10.0 SYSTEM EXCLUSIVE MESSAGES RESET DEVICE

<F0>	System Exclusive Message ID (SYSEX)
<0D>	ADA Identifier
<cc>	Channel number
<dd>	Device number
<01>	Reset Device command
<xx>	Message checksum
<F7>	End of system exclusive (SYSEX)

- Causes the specified device to perform a reset operation.
- Specifics of the reset are device dependent.
- No response is sent by the device.

### RUN DIAGNOSTIC TEST

<F0>	SYSEX
<0D>	ADA Identifier
<cc>	Channel number
<dd>	Device number
<02>	Run diagnostic test command
<tt>	Test number
<xx>	Message checksum
<F7>	EOX

- Causes the specified device to run a selected diagnostic test routine.
- Test 00 is equivalent to power-on diagnostic.
- Other test numbers are device specific.
- No response is sent by the device.

### REPORT DIAGNOSTIC STATUS

<F0>	SYSEX
<0D>	ADA Identifier
<cc>	Channel number
<dd>	Device number
<03>	Report diagnostic status
<xx>	Message checksum
<F7>	EOX

### 1.3 PRECAUTIONS

**WARNING:** To prevent fire or shock hazard, do not expose this appliance to rain or moisture. Locate the MP-1 out of the direct rays of the sun. Avoid locations subject to vibration and excessive dust, heat or cold.

**CAUTION:** To prevent shock, do not remove cover. No user serviceable parts inside. Refer servicing, including tube replacement, to qualified service personnel.

**RETAIN INSTRUCTIONS:** Keep this manual in a safe location for future reference.

**CLEANING:** Do not clean your MP-1 with chemical solvents such as benzene or alcohol. Wipe only with a clean dry cloth.

### 2.0 CONTROL FUNCTIONS

<b>CLIP</b>	Monitors signal level at four points of the circuit to prevent unwanted distortion. Set levels so LED's light only on the largest transients (See Section 3.0 for detailed description).
<b>INPUT</b>	Accepts instrument level 1/4" phone plug.
<b>OUTPUT LEVEL</b>	Sets volume without affecting tone or amount of distortion.
<b>LED READOUT</b>	Displays MP-1's internal memory number when not Edit mode (See Section 4.0 for description of program and memory numbers). Displays MIDI Channel, external MIDI program number or internal memory number in MIDI mode. In Edit mode, displays level of Overdrive, Master Gain, EQ boost or cut, Effects loop in / out, Chorus Depth and Rate settings, and Voicing choice of Clean Tube, Distortion Tube or Solid State.
<b>^v</b>	Scrolls through programs. When in Edit or MIDI mode, increases or decreases value of selected parameter.

### GO OFFLINE

<F0>	System Exclusive Message ID (SYSEX)
<0D>	ADA Identifier
<cc>	Channel number
<dd>	Device number
<05>	Offline command
<xx>	Message checksum
<F7>	End of system exclusive (SYSEX)

- Causes the specified device to go offline until manually returned online.
- No response is returned by the device.

### GET PARAMETERS

<F0>	SYSEX
<0D>	ADA Identifier
<cc>	Channel number
<dd>	Device number
<07>	Get parameters command
<pp>	Program number
<NN>	Number of parameters
<P <sub>1</sub> >	Parameter 1 value
•	
•	
•	
<P <sub>N</sub> >	Parameter N value
<xx>	Message checksum
<F7>	EOX

- Causes the specified device to send the value of one or more selected parameters..
- Program number 7F specifies the current working parameter registers.

**STORE YOUR TONE:**

- 1 To store the new values that you have set, press STORE button.
- 2 Select the location (Memory numbers 1-128) for storing your program.

**SELECT MIDI CHANNEL:**

- 1 Press MIDI CHNL button.
- 2 Use ^v buttons to select MIDI channel from 1 through 16, ALL (OMNI), or OFF (MIDI reception disabled).
- 3 PRESS MIDI CHNL to save and exit.

**DIRECTING MIDI PROGRAM CHANGE INFORMATION TO DIFFERENT INTERNAL MEMORY NUMBERS:**

- 1 Press PRGM button.
- 2 Select a MIDI program number by using ^v buttons to scroll through MIDI program numbers 1 Through 128 or select directly using BANK and 0 through 12.
- 3 Press MEM button.
- 4 Select an internal memory number using the ^v buttons to scroll through the 1-128 memory numbers or select directly using BANK and 0 through 9.
- 5 Press MEM to save the change and exit.

**LOAD PRESET PROGRAMS ( 1 THROUGH 29).**

- 1 Press STORE button. Press BANK, and, while holding, press 1. Display shows "LP".

**NOTES ON ADA SYSTEM EXCLUSIVE MESSAGES**

- 1 All messages include a 7 bit 2's complement checksum taken over all of the data bytes (doesn't include the SYSEX, EOX, or checksum itself).
- 2 Values are in "Humber" format (MS bits sent first):

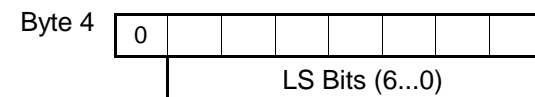
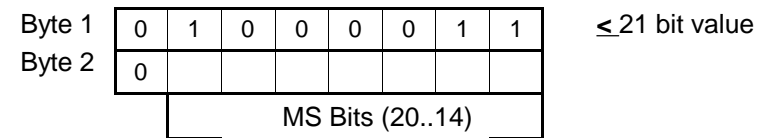
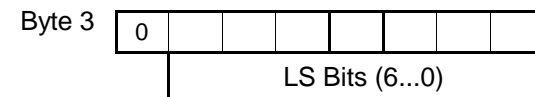
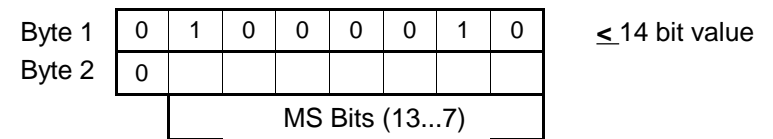
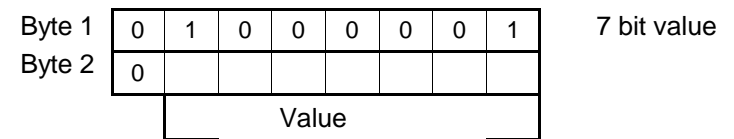
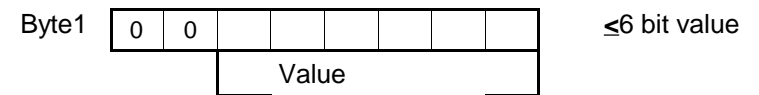

- 70...7F as byte 1 are reserved for special single byte codes.



## 1.0 INTRODUCTION

Thank you for purchasing the ADA MP-1 MIDI Programmable Tube preamp. You now own the most tonally flexible and technologically advanced guitar preamplification device available. Your MP-1 will store 128 programs of exactly the right tone, no matter what kind of music you play.

The MP-1 features a unique Tri-State Voicing selection that allows you to choose between Distortion Tube, Clean Tube, or Solid State circuits for each program. The EQ points were designed to replicate the sounds of Fender™ and Marshall™, but the Presence control surpasses the range offered by either. The Stereo Chorus utilizes analog circuitry which complements the warmth of tubes to give you the best possible sound.

The software in the MP-1 provides the fullest implementation of MIDI available. Since the MP-1 is software based, it will never grow obsolete. As the MIDI standard evolves, your MP-1 can be updated by simply changing the program ROM. In the manual, you will find references to different levels of software. When you power up your MP-1, the display indicates which level of software is installed. On power-up, "ADA" is displayed first, followed by a three-digit number. The first of these digits is the level of software installed.

To properly set up and familiarize yourself with the MP-1, read and follow these operating instructions completely. If you can't wait, and want to jump right into the MP-1, go to Section 1.1 QUICK SETUP.

We hope that the unlimited tonal possibilities and unmatched technological capabilities of your MP-1 will inspire you to great things.

**IMPORTANT:** *Please take this time to fill out and return the enclosed warranty card so we may provide you with information on future software updates.*

## 10.2 SYSTEM EXCLUSIVE PARAMETER VALUES

- 1 Level 2 MIDI implementation.
- 2 MIDI System Reset is ignored by MP-1.

MIDI VALUE	OVERDRIVE 1&2 DISPLAY VALUE
0	0
1	.1
2	.2
3	.3
4	.4
5	.5
6	.6
7	.7
8	.8
9	.9
10	1.0
11	1.2
12	1.4
13	1.6
14	1.8
15	2.0
16	2.2
17	2.4
18	2.6
19	2.8
20	3.0
21	3.2
22	3.4
23	3.6
24	3.8
25	4.0
26	4.2
27	4.4
28	4.6
29	4.8
30	5.0
31	5.5
32	6.0
33	6.5
34	7.0
35	7.5
36	8.0
37	8.5
38	9.0
39	9.5
40	10.0